

0696 62 E

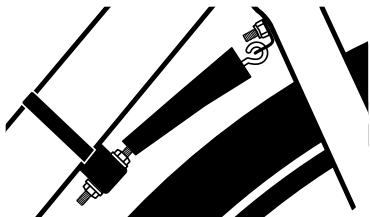

0695 32

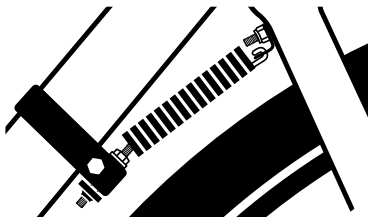

0695 UNI

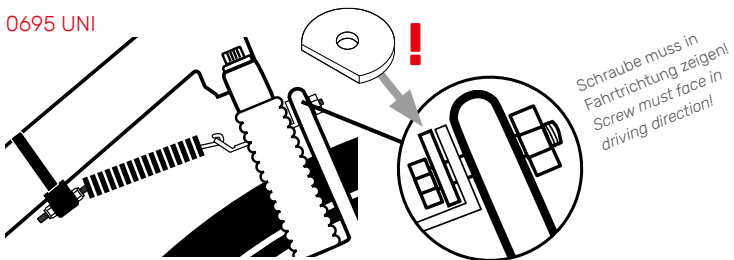

Schraube muss in Fahrtrichtung zeigen
Screw must face in driving direction!

0696 UNI

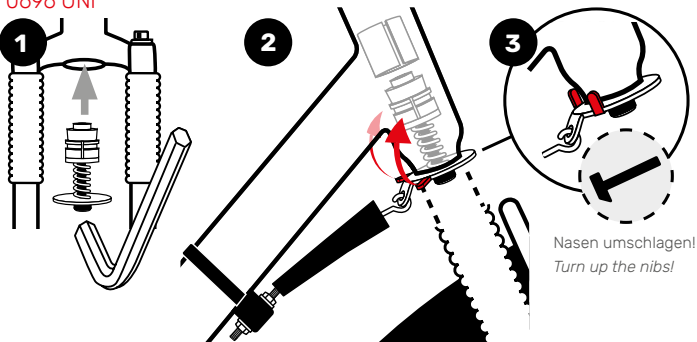

Nasen umschlagen!
Turn up the nibs!

MONTAGEHINWEISE MOUNTING INSTRUCTIONS

LENKUNGSDÄMPFER STEERING STABILIZER

Zubehör - Ersatzteile | Accessories - spare parts

- 0699 19 Feder kurz (65 mm) | Spring short
- 0699 20 Feder lang (108 mm) | Spring long
- 0699 22 Feder extra lang (135 mm) | Spring extra long
- 0699 90 Kunststoffblock Direktbefestigung | Plastic block for direct fitting
(benötigt Rahmenöse mit M5 Gewinde | needs an eyelet with thread M5)
- 0699 15 Haltewinkel lang 23/21 mm | Stainless steel bracket long 23/21 mm
- 0699 96 Klemmkonus Federgabel | Clamping cone for suspension fork
- 0699 97 Elastomerkörper einzeln | Elastomer element single

weiteres Zubehör s. www.hebie.de | more accessories on www.hebie.de



0699 19-22



0699 90



0699 15



0699 97



0699 96

Hebie GmbH & Co. KG

Sandhagen 16 | 33617 Bielefeld | Germany

+49 521 91419-0

service@hebie-group.com

hebie.de | hebie-group.com



1

Schellenband | Strap
 Ø 32-62 mm

Schutzfolie um
 den Rahmen legen!
 Please put the
 protective foil around
 the frame!

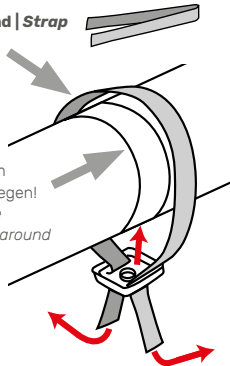

0695 32

Rahmenschelle | Frame ring
 Ø 28-32 mm

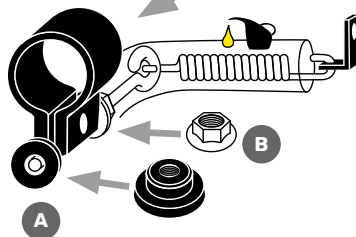

2

Feder Standardlänge
 Spring standard length
 73 mm

0695 UNI

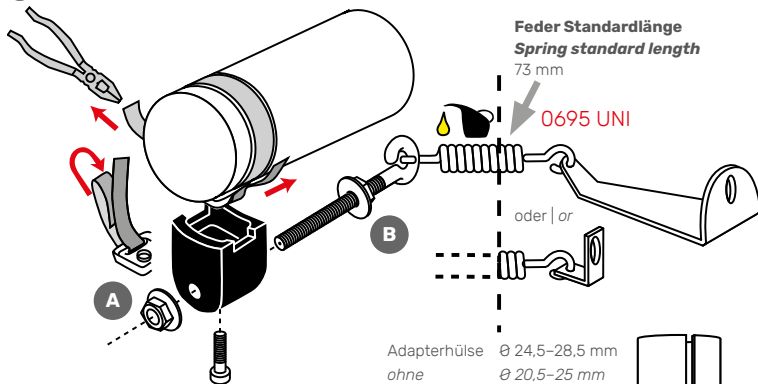

Adapterhülse Ø 24,5-28,5 mm
 ohne Ø 20,5-25 mm
 adapter Ø 24,5-28,5 mm
 w/o Ø 20,5-25 mm

0696 62



Bitte keine aggressiven Reini-
 gungsmittel (Benzine etc.) für
 den Elastomer verwenden!
 Please do not use strong
 cleaning materials (benzine
 etc.) for the elastomer.

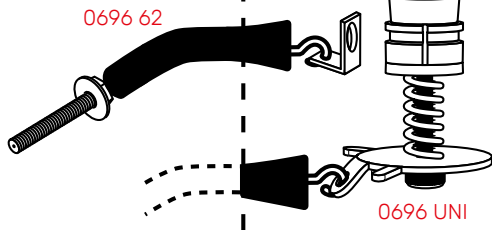

0696 UNI

MONTAGEHINWEISE MOUNTING INSTRUCTIONS

LENKUNGSDÄMPFER STEERING STABILIZER

In diesen Montagehinweisen werden vier hebie-Lenkungsdämpfer beschrieben:

0695 32 - 0695 UNI - 0696 62 - 0696 UNI

Für Sie relevant sind nur die in dieser Verpackung enthaltenen Produkte.

Montieren Sie den Lenkungsdämpfer 0695|0696 am unteren Rahmenrohr und mit dem Winkel am Gabelkopf (0695 UNI auch an Gabelbrücke, 0696 UNI mit Konusklemme im Gabelschaft). Die individuelle Feineinstellung des Lenkungsdämpfers erzielen Sie durch Verdrehen der Rändelschraube an der Rahmenrohrschelle (s. A). Mit Mutter B gegenkontern. **Je nach Anbausituation bleiben ggf. Teile übrig.**

Several hebie coupling systems are described in these mounting instructions:

0695 32 - 0695 UNI - 0696 62 - 0696 UNI

Only the products included in the packaging are relevant for you.

Please fit 0695|0696 steering stabilizer to the downtube and its hook onto the head of the fork (0695 UNI onto fork bridge, 0696 UNI with conus into the fork tube). Please turn the screw on the tube clip (see A) in order to adjust your steering stabilizer system properly. Fix the position with screw nut B. **Depending on the mounting some parts might be left over.**



Raccolla differenziata.
 Verifica le disposizioni del tuo comune.

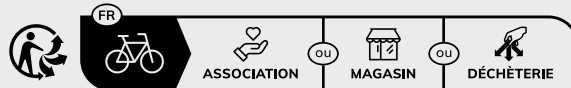

quefairedemesdechets.fr

Privilégiez la réparation ou le don